



MEENAKSHI SUNDARARAJAN ENGINEERING COLLEGE

(Managed by I.I.E.T. Society, Approved by AICTE, New Delhi)

Affiliated to Anna University, Chennai.

Accredited by BAAC with 'A' grade and NBA for programs applied.

Recognized by UGC with 2(f) & 12(B) status.)



383, Arcot Road, Kodambakkam, Chennai – 600 024, Tamil Nadu, India



2.3.2. Teachers use ICT enabled tools for effective teaching-learning process

INDEX

S.NO	CONTENT	Page No
1	List of ICT tools used	2
2	Smart Class Room	3
3	Computer assisted learning	6
4	Google Class Room	8
5	Video Lecturing	12
6	Course PPT and materials	14
7	Google Forms	17
8	Online Platform test	20
9	E-book and E-journal facilities available in library	22
10	Online Courses	23
11	Demo based learning for theoretical concepts	25

PREPARED BY

V. Sundari
[V. Sundari]

VERIFIED BY

CK. Rajan

APPROVED BY



PRINCIPAL
MEENAKSHI SUNDARARAJAN ENGINEERING COLLEGE
363, ARCOT ROAD, KODAMBAKKAM
CHENNAI-600 024



MEENAKSHI SUNDARARAJAN ENGINEERING COLLEGE

(Managed by I.I.E.T Society, Approved by AICTE, New Delhi,

Affiliated to Anna University, Chennai,

Accredited by NAAC with 'A' grade and NBA for programs applied,

Recognized by UGC with 2(f) & 12(B) status)

363, Arcot Road, Kodambakkam, Chennai – 600 024, Tamil Nadu, India



1. List of ICT tools used

- Smart class room
- Computer assisted learning
- Google class room
- Online class room
- Lab experiments through video lecturing
- Course PPT and materials available in college website
- E-book and E-journal facilities available in library
- Naan Muthalvan, NPTEL and SWAYAM courses

PRINCIPAL
MEENAKSHI SUNDARARAJAN ENGINEERING COLLEGE
363, ARCOT ROAD, KODAMBAKKAM
CHENNAI-600 024



MEENAKSHI SUNDARARAJAN ENGINEERING COLLEGE

(Managed by I.J.E.T. Society, Approved by AICTE, New Delhi.

Affiliated to Anna University, Chennai.

Accredited by NAAC with 'A' grade and NBA for programs applied.

Recognized by UGC with 2(f) & 12(B) status)

363, Arcot Road, Kodambakkam, Chennai – 600 024, Tamil Nadu, India



2. SMART CLASS ROOM

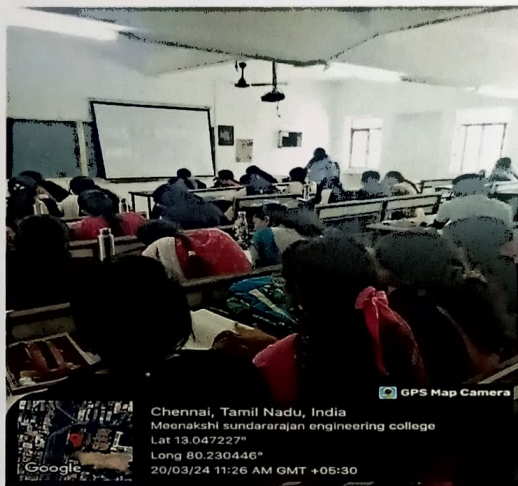

Department of Artificial Intelligence and Data Science

PRINCIPAL
MEENAKSHI SUNDARARAJAN ENGINEERING COLLEGE
363, ARCOT ROAD, KODAMBAKKAM
CHENNAI-600 024



MEENAKSHI SUNDARARAJAN ENGINEERING COLLEGE

(Managed by I.I.E.T. Society, Approved by AICTE, New Delhi)

Affiliated to Anna University, Chennai,

Accredited by NAAC with 'A' grade and NBA for programs applied,

Recognized by UGC with 2(I) & 12(B) status)

363, Arcot Road, Kodambakkam, Chennai – 600 024, Tamil Nadu, India

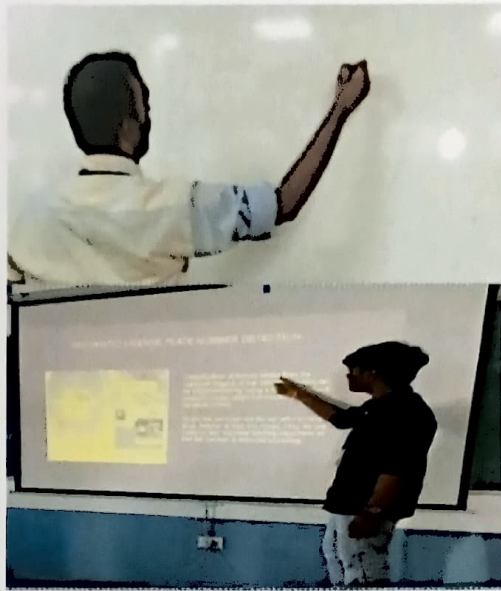

Department of Information and Technology

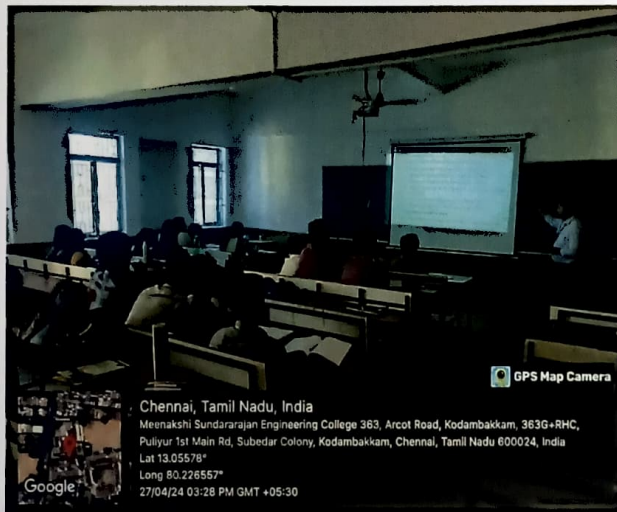

Department of Civil Engineering

PRINCIPAL
MEENAKSHI SUNDARARAJAN ENGINEERING COLLEGE
363, ARCOT ROAD, KODAMBAKKAM
CHENNAI-600 024



MEENAKSHI SUNDARARAJAN ENGINEERING COLLEGE

(Managed by I.I.E.T. Society, Approved by AICTE, New Delhi)

Affiliated to Anna University, Chennai

Accredited by NAAC with 'A' grade and NBA for programs applied.

Recognized by UGC with 2(f) & 12(B) status)

363, Arcot Road, Kodambakkam, Chennai – 600 024, Tamil Nadu, India



Topic : Naan Muthalvan – Design thinking

Date: 08/04/2024

Venue : II CSE Classroom

Target Audience : II CSE Students



Topic : VIGYAN 2024 – One day technical seminar

Date: 16/02/2024

Venue : ECE Seminar Hall

Target Audience : CSE Students

Resource Person : Mr. Subramanian Radhakrishnan, Chief Enterprise Architect, Infosys Limited, Chennai

**PRINCIPAL
MEENAKSHI SUNDARARAJAN ENGINEERING COLLEGE
363, ARCOT ROAD, KODAMBAKKAM
CHENNAI-600 024**



MEENAKSHI SUNDARARAJAN ENGINEERING COLLEGE

(Managed by I.J.E.T. Society, Approved by AICTE, New Delhi)

Affiliated to Anna University, Chennai

Accredited by NAAC with 'A' grade and NBA for programs applied.

Recognized by UGC with 2(F) & 12(B) status

363, Arcot Road, Kodambakkam, Chennai – 600 024, Tamil Nadu, India

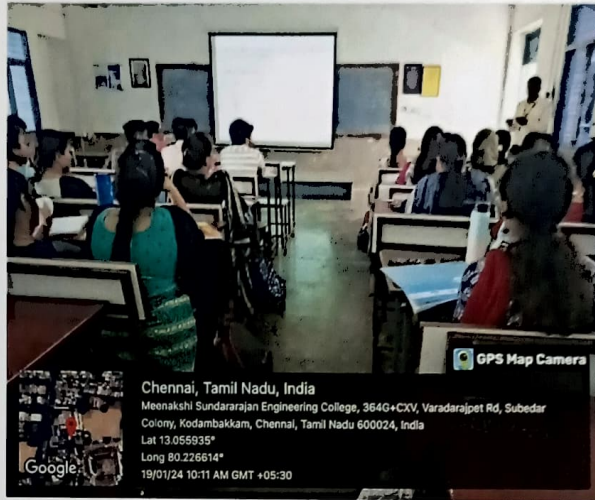

Topic : Placement training

Date: 19/01/2024

Venue : IV CSE Classroom

Target Audience : IV CSE Students

3. Computer Assisted Learning

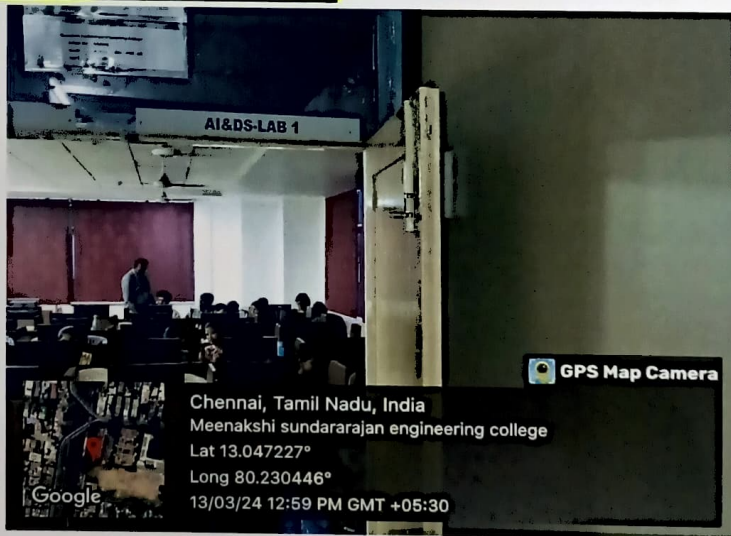

Computer Assisted Learning (AIDS Students)



MEENAKSHI SUNDARARAJAN ENGINEERING COLLEGE

(Managed by I.I.E.T Society, Approved by AICTE, New Delhi)

Affiliated to Anna University, Chennai.

Accredited by NAAC with 'A' grade and NBA for programs applied.

Recognized by UGC with 2(f) & 12(B) status)

363, Arcot Road, Kodambakkam, Chennai – 600 024, Tamil Nadu, India

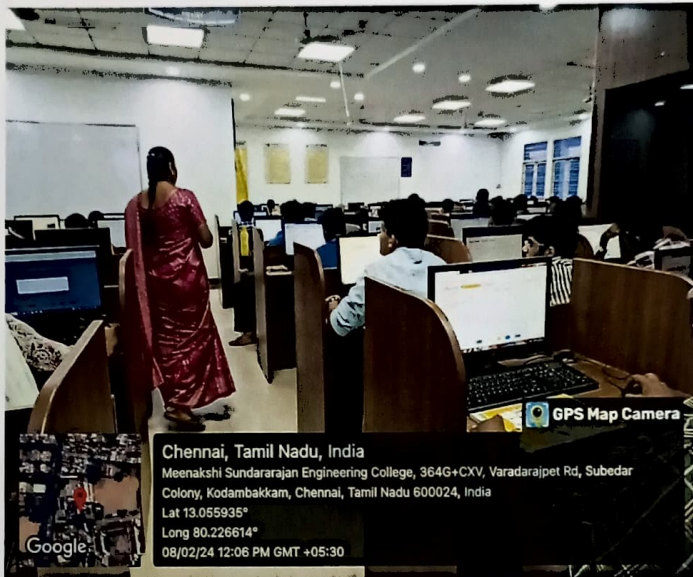

Computer Assisted Learning (CSE Students)

PRINCIPAL
MEENAKSHI SUNDARARAJAN ENGINEERING COLLEGE
363, ARCOT ROAD, KODAMBAKKAM
CHENNAI-600 024



MEENAKSHI SUNDARARAJAN ENGINEERING COLLEGE

(Managed by I.I.E.T Society, Approved by AICTE, New Delhi)

Affiliated to Anna University, Chennai.

Accredited by NAAC with 'A' grade and NBA for programs applied.

Recognized by UGC with 2(f) & 12(B) status

363, Arcot Road, Kodambakkam, Chennai – 600 024, Tamil Nadu, India



4. Google Class Room

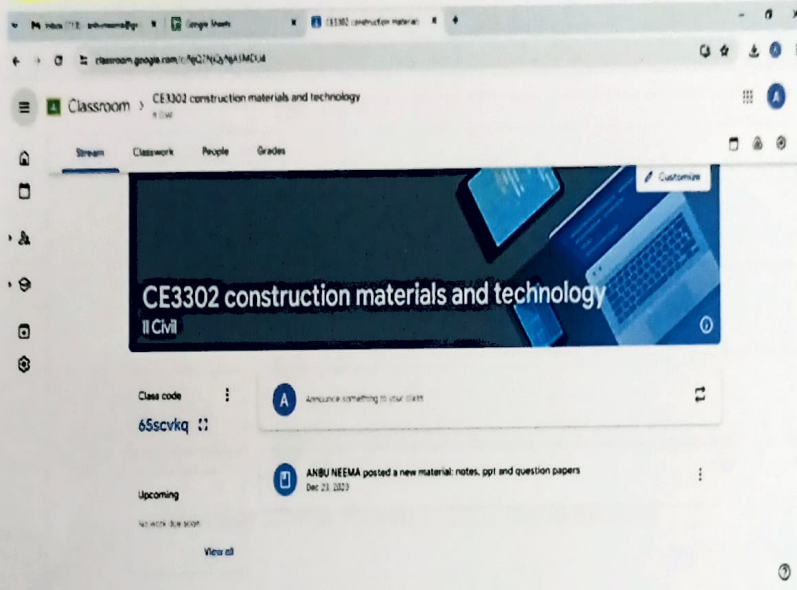

(Google Class Room – Civil Department)

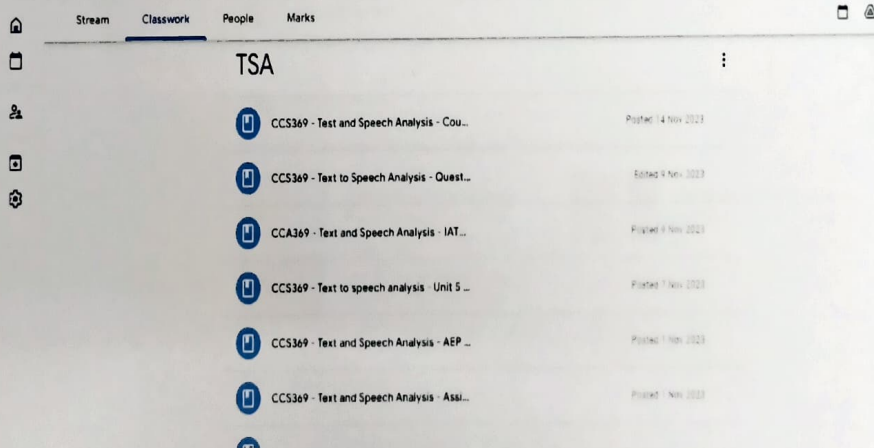

(Google Class Room – CSE Department)



MEENAKSHI SUNDARARAJAN ENGINEERING COLLEGE

(Managed by I.I.E.T. Society, Approved by AICTE, New Delhi)

Affiliated to Anna University, Chennai.

Accredited by NAAC with 'A' grade and NBA for programs applied.

Recognized by UGC with 2(f) & 12(B) status)

363, Arcot Road, Kodambakkam, Chennai – 600 024, Tamil Nadu, India



Classroom > CS3352 - FOUNDATIONS OF DATA SCIENCE (Acad...
II SEM - Sem 3 (Batch 2022-2018)

Stream Classwork People Marks

- C Jerin Mahibha posted a new material: CS3352 - Foundations of Data Science - Unit 10 Test - 22 Dec 2023
- C Jerin Mahibha posted a new material: CS3352 - Foundations of Data Science - Question Ba... 22 Dec 2023
- C Jerin Mahibha posted a new material: CS3352 - Foundations of Data Science - AEP Test - 2... 22 Dec 2023
- C Jerin Mahibha posted a new material: CS3352 - Foundations of Data Science - Assignment 5 22 Dec 2023
- C Jerin Mahibha posted a new material: CS3352 - Foundations of Data Science - PPT - Unit 5 22 Dec 2023

(Google Class Room – CSE Department)

II year A EC3452 Electromagnetic Fields

Stream Classwork People Grades

Add class comment.

Bhargavi Sekaran
Mar 13

I have shared videos on EMF for basic understanding of concepts. Please check

- Electromagnetic Fields Le...
YouTube video · 17 minutes
- Electromagnetic Fields Le...
YouTube video · 17 minutes
- The origin of Electromagn...
YouTube video · 12 minutes

Add class comment.

(Google Class Room – ECE Department)

PRINCIPAL
MEENAKSHI SUNDARARAJAN ENGINEERING COLLEGE
363, ARCOT ROAD, KODAMBAKKAM
CHENNAI-608 024



MEENAKSHI SUNDARARAJAN ENGINEERING COLLEGE

(Managed by I.E.T Society, Approved by AICTE, New Delhi.)

Affiliated to Anna University, Chennai.

Accredited by NAAC with 'A' grade and NBA for programs applied.

Recognized by UGC with 2(f) & 12(B) status)

363, Arcot Road, Kodambakkam, Chennai – 600 024, Tamil Nadu, India

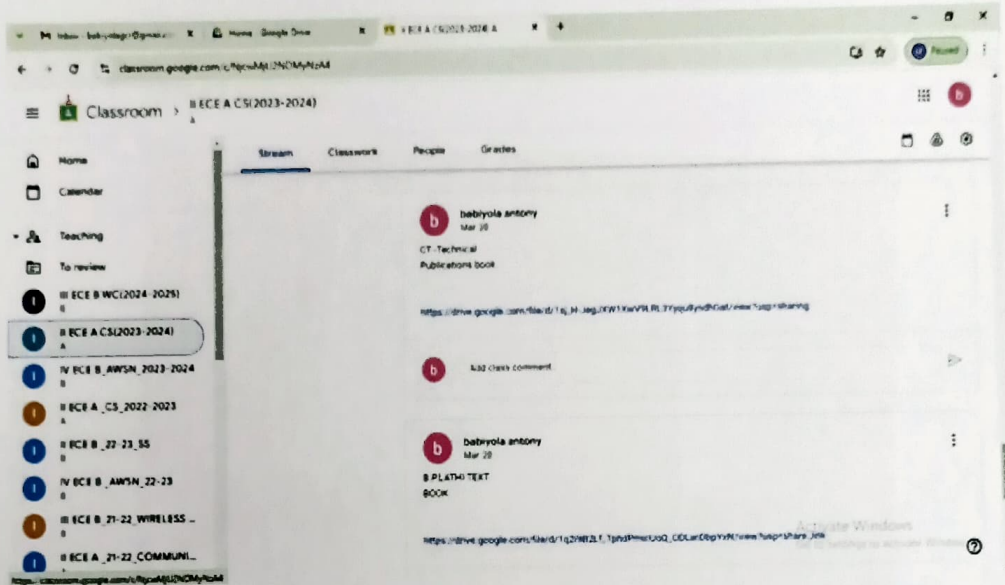

(Google Class Room – ECE Department)

PRINCIPAL
MEENAKSHI SUNDARARAJAN ENGINEERING COLLEGE
363, ARCOT ROAD, KODAMBAKKAM
CHENNAI-600 024



MEENAKSHI SUNDARARAJAN ENGINEERING COLLEGE

(Managed by I.I.E.T Society, Approved by AICTE, New Delhi.)

Affiliated to Anna University, Chennai.

Accredited by NAAC with 'A' grade and NBA for programs applied.

Recognized by UGC with 2(f) & 12(B) status.)

363, Arcot Road, Kodambakkam, Chennai – 600 024, Tamil Nadu, India



5. Video Lecturing

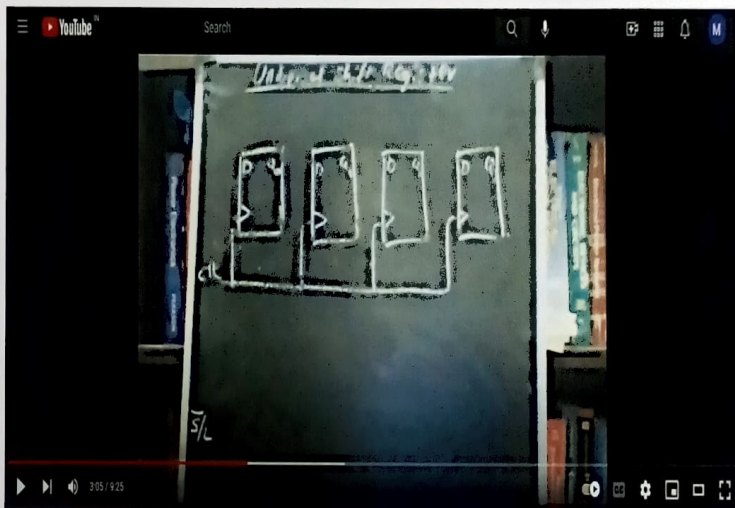

Digital Logic Circuits Lecture 21.5 Universal Shift Registers (EEE)...

<https://www.youtube.com/watch?v=dLX8AedP5R0>

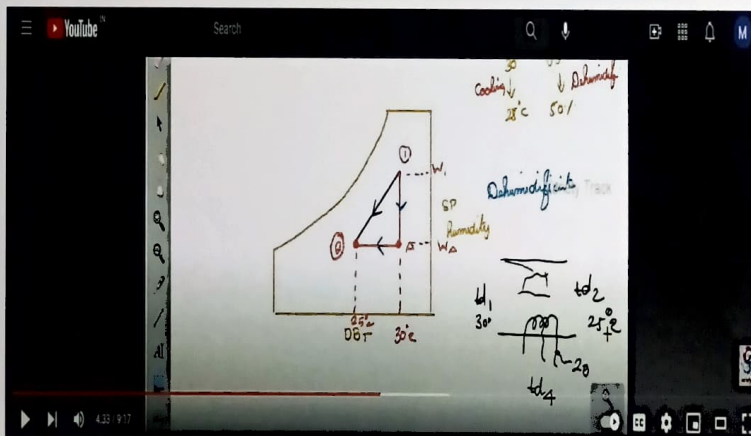

PRINCIPAL
MEENAKSHI SUNDARARAJAN ENGINEERING COLLEGE
363, ARCOT ROAD, KODAMBAKKAM
CHENNAI-600 024



MEENAKSHI SUNDARARAJAN ENGINEERING COLLEGE
 (Managed by I.I.E.T Society, Approved by AICTE, New Delhi.

Affiliated to Anna University, Chennai.

Accredited by NAAC with 'A' grade and NBA for programs applied,

Recognized by UGC with 2(f) & 12(B) status)

363, Arcot Road, Kodambakkam, Chennai – 600 024, Tamil Nadu, India



Psychrometric|video 19|cooling and Dehumidification|UNIT V GAS MIXTURES
 AND PSYCHROMETRY (Mechanical)

https://www.youtube.com/watch?v=o9lexE-t_m8

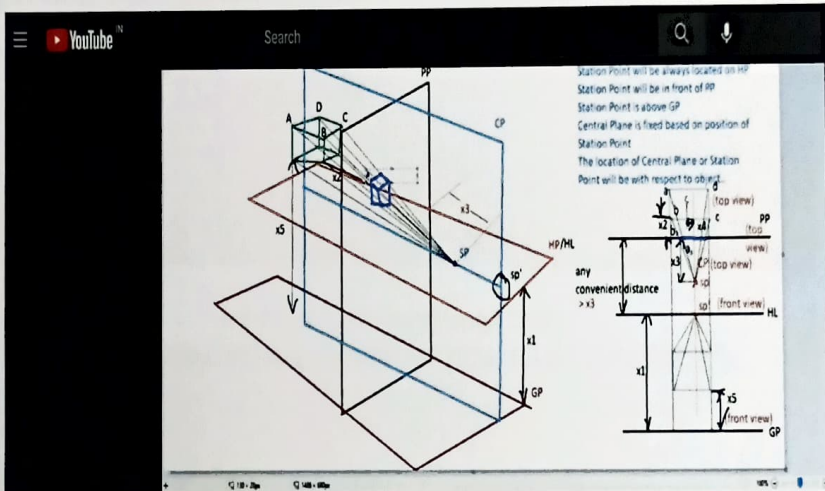

Perspective Projection, Free Hand Sketch and Revision (Civil)

https://www.youtube.com/watch?v=cP_Ew7UjboA

[Handwritten signature]

PRINCIPAL
MEENAKSHI SUNDARARAJAN ENGINEERING COLLEGE
363, ARCOT ROAD, KODAMBAKKAM
CHENNAI-600 024



MEENAKSHI SUNDARARAJAN ENGINEERING COLLEGE

(Managed by I.I.E.T. Society, Approved by AICTE, New Delhi)

Affiliated to Anna University, Chennai.

Accredited by NAAC with 'A' grade and NBA for programs applied.

Recognized by UGC with 2(F) & 12(B) status)

363, Arcot Road, Kodambakkam, Chennai – 600 024, Tamil Nadu, India



```

Python 3.9.2 (tags/v3.9.2:lia=[])
5, Feb 19 2021, 13:44:55) [In=nt(input("Enter the number of el
.1928 64 bit (AMD64)] on winfor i in range(0,n):
Type "help", "copyright", "x=int(input("Enter the element
ts" or "license()" for more a.append(x)
rmation. max = a[0]
>>> for i in range(1,n):
= RESTART: C:\Users\ganig\A if a[i]>max:
a\Local\Programs\Python\Pyt max=a[i]
\sample1.py print("Max element in the list : ",
Enter the number of element:
Enter the element : 23
Enter the element : 67
Enter the element : 44
Enter the element : 90
Enter the element : 23
Play (N)
Max element in the list :

```

Python programming (CSE)

<https://www.youtube.com/watch?v=uNol7URKExU&t=56s>

6. Course PPT and materials

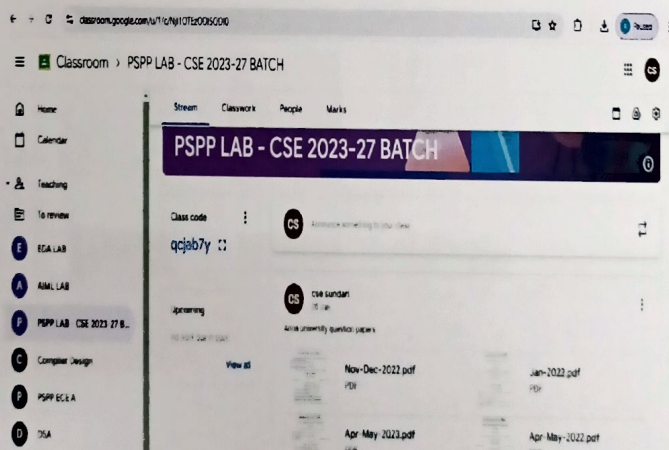

(Course Material – CSE Department)

PRINCIPAL
MEENAKSHI SUNDARARAJAN ENGINEERING COLLEGE
363, ARCOT ROAD, KODAMBAKKAM
CHENNAI-600 024



MEENAKSHI SUNDARARAJAN ENGINEERING COLLEGE

(Managed by I.I.E.T Society, Approved by AICTE, New Delhi,

Affiliated to Anna University, Chennai,

Accredited by NAAC with 'A' grade and NBA for programs applied,

Recognized by UGC with 2(f) & 12(B) status)

363, Arcot Road, Kodambakkam, Chennai – 600 024, Tamil Nadu, India

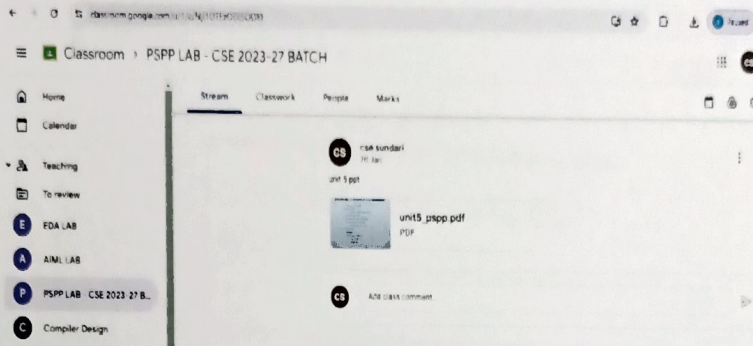

(Course Material – CSE Department)

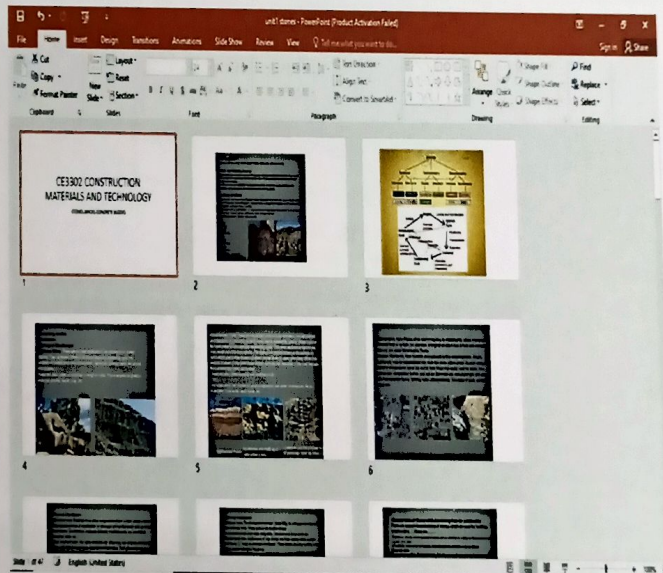

[Handwritten signature]

PRINCIPAL
MEENAKSHI SUNDARARAJAN ENGINEERING COLLEGE
363, ARCOT ROAD, KODAMBAKKAM
CHENNAI-600 024



MEENAKSHI SUNDARARAJAN ENGINEERING COLLEGE

(Managed by I.E.T. Society, Approved by AICTE, New Delhi)

Affiliated to Anna University, Chennai.

Accredited by NAAC with 'A' grade and NBA for programs applied.

Recognized by UGC with 2(F) & 12(B) status)

363, Arcot Road, Kodambakkam, Chennai – 600 024, Tamil Nadu, India



7. Google Forms

CS3501 - COMPILER DESIGN - COURSE SURVEY 2021-2025

Questions Responses 50 Settings

CS3501 - COMPILER DESIGN - COURSE SURVEY - BATCH 2021-2025

COMPUTER SCIENCE AND ENGINEERING - III YEAR - V SEMESTER - BATCH (2021-2025)

Regulation 2021

Course Code & Course Name C302 - COMPILER DESIGN

Email *

valid email address

This form is collecting email addresses. Change settings

Questions Responses 50 Settings

C302.1 Understand the techniques in different phases of a compiler & Design a lexical analyser for a sample language and learn to use the LEX tool. *

3

2

1

...

C302.2 Apply different parsing algorithms to develop a parser and learn to use YACC tool. *

3

2

1

(Google Form – CSE Department)

PRINCIPAL
MEENAKSHI SUNDARARAJAN ENGINEERING COLLEGE
363, ARCOT ROAD, KODAMBAKKAM
CHENNAI-600 024



MEENAKSHI SUNDARARAJAN ENGINEERING COLLEGE

(Managed by I.I.E.T Society, Approved by AICTE, New Delhi,)

Affiliated to Anna University, Chennai.

Accredited by NAAC with 'A' grade and NBA for programs applied.

Recognized by UGC with 2(I) & 12(B) status)

363, Arcot Road, Kodambakkam, Chennai – 600 024, Tamil Nadu, India



Questions Responses **50** Settings

C302.1 Understand the techniques in different phases of a compiler & Design a lexical analyser for a sample language and learn to use the LEX tool. [Copy chart](#)

50 responses

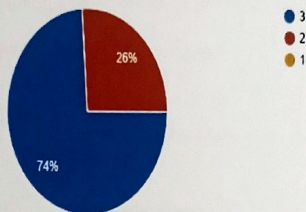

C302.2 Apply different parsing algorithms to develop a parser and learn to use YACC tool. [Copy chart](#)

50 responses



Google form responses (CSE Department)

PRINCIPAL
MEENAKSHI SUNDARARAJAN ENGINEERING COLLEGE
363, ARCOT ROAD, KODAMBAKKAM
CHENNAI-600 024



MEENAKSHI SUNDARARAJAN ENGINEERING COLLEGE

(Managed by I.I.E.T Society, Approved by AICTE, New Delhi,

Affiliated to Anna University, Chennai,

Accredited by NAAC with 'A' grade and NBA for programs applied,

Recognized by UGC with 2(F) & 12(B) status)

363, Arcot Road, Kodambakkam, Chennai – 600 024, Tamil Nadu, India



8. Online Platform test

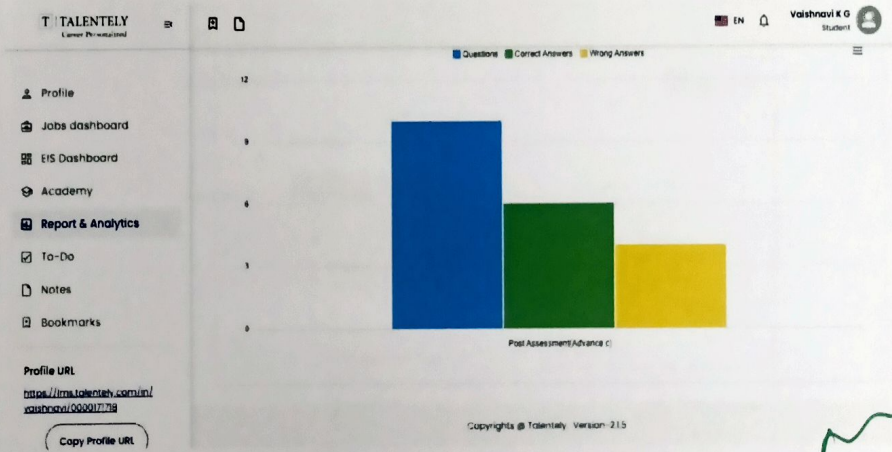
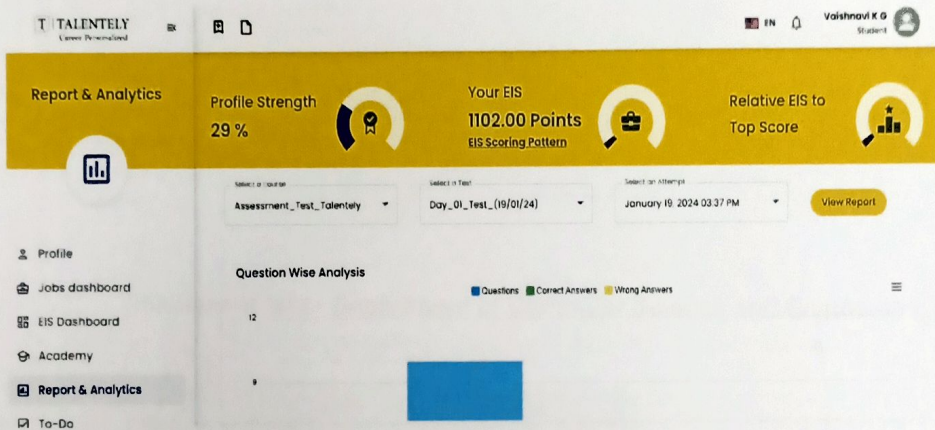

PRINCIPAL
 MEENAKSHI SUNDARARAJAN ENGINEERING COLLEGE
 363, ARCOT ROAD, KODAMBAKKAM
 CHENNAI-600 024



MEENAKSHI SUNDARARAJAN ENGINEERING COLLEGE
 (Managed by I.E.T Society, Approved by AICTE, New Delhi,

Affiliated to Anna University, Chennai,

Accredited by NAAC with 'A' grade and NBA for programs applied,

Recognized by UGC with 2(F) & 12(B) status)

363, Arcot Road, Kodambakkam, Chennai – 600 024, Tamil Nadu, India

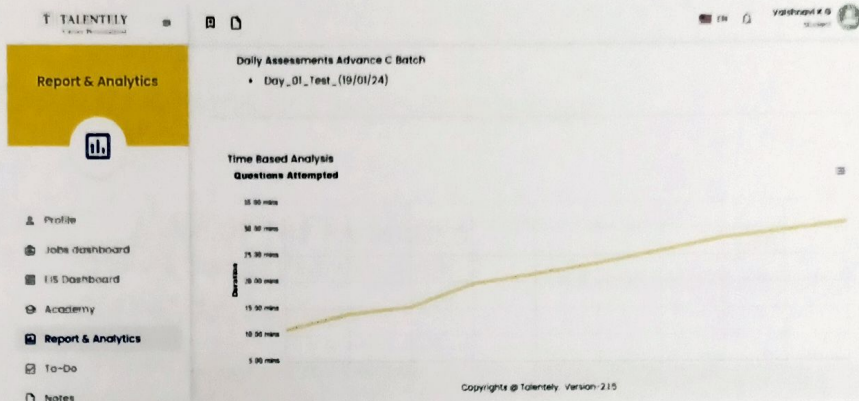

(Placement test - Department of Computer Science and Engineering)

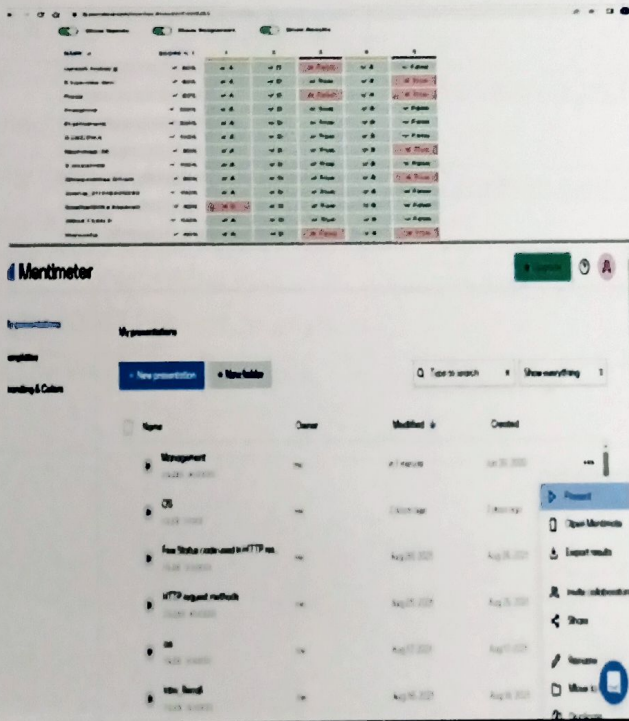

(Department of Information and Technology)

PRINCIPAL
MEENAKSHI SUNDARARAJAN ENGINEERING COLLEGE
 363, ARCOT ROAD, KODAMBAKKAM
 CHENNAI-600 024



MEENAKSHI SUNDARARAJAN ENGINEERING COLLEGE

(Managed by I.I.E.T Society, Approved by AICTE, New Delhi,

Affiliated to Anna University, Chennai,

Accredited by NAAC with 'A' grade and NBA for programs applied,

Recognized by UGC with 2(I) & 12(B) status)

363, Arcot Road, Kodambakkam, Chennai – 600 024, Tamil Nadu, India



9. E-book and E-journal facilities available in library

SL.NO	NAME OF THE PACKAGES	URL
1.	IEEE-All Society Periodicals(ASPP ONLINE) 206 Journals	http://ieeexplore.ieee.org/Xplore/
2.	Springer Nature (Engineering, Computer Science, Mathematics and Statistics) 497 Titles	https://link.springer.com/
3.	ASME(American Society of Mechanical Engineering) 33 Journals	http://asmedigitalcollection.asme.org
4.	ASCE(American Society Of Civil Engineering) 35 Journals	http://ascelibrary.org/
5.	ASTM International(American Society for Testing Materials) 9 Journals	https://myastm.astm.org
6.	J-Gate (J-Gate Engineering and Technology) 20963 Full text Journals.	https://jgateplus.com/
7.	Z Library(The World Largest eBook Library)	https://z-lib.org/

PRINCIPAL
MEENAKSHI SUNDARARAJAN ENGINEERING COLLEGE
363, ARCOT ROAD, KODAMBAKKAM
CHENNAI-600 024



MEENAKSHI SUNDARARAJAN ENGINEERING COLLEGE

(Managed by U.E.T. Society, Approved by AICTE, New Delhi)

Affiliated to Anna University, Chennai

Accredited by NAAC with 'A' grade and NBA for programs applied.

Recognized by UGC with 2(f) & 12(B) status)

363, Arcot Road, Kodambakkam, Chennai – 600 024, Tamil Nadu, India



10. Online Courses

3:37

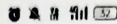

← ▾ ☰ Desing_Thinkin... ↲ ⋮
lms.career-shaper.com

15% **Hi Abinaya S :)**
You are doing great!

TNSDC_JFM24_Design_Thinking_01

My Job Learning >
Assignment and Projects >
List, Template and
Submission > Projects

Projects List

Design Thinking – Project List

Project Code	Project Title
DT001	Algebra Assist: Creating Connected Classrooms for Math Mastery

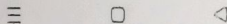

(Naan Muthalvan – AIDS, CSE & IT Department)

PRINCIPAL
MEENAKSHI SUNDARARAJAN ENGINEERING COLLEGE
363, ARCOT ROAD, KODAMBAKKAM
CHENNAI-600 024



MEENAKSHI SUNDARARAJAN ENGINEERING COLLEGE

(Managed by I.E.T Society, Approved by AICTE, New Delhi),

Affiliated to Anna University, Chennai,

Accredited by NAAC with 'A' grade and NBA for programs applied,

Recognized by UGC with 2(f) & 12(B) status)

363, Arcot Road, Kodambakkam, Chennai – 600 024, Tamil Nadu, India



3:37

🔍 📄 🗨️ (32)

19% **Hi Abinaya S :)**
You are doing great!



TNSDC_JFM24_Design_Thinking_01

- My Job Learning >**
- Assignment and Projects >**
- List, Template and Submission >**
- Assignments**

Assignments

Assignments – Design Thinking

Attempt all questions.

S.No	Module	Problem Statement
		As a project manager, you are assigned with task to generate reports on bug statistics and trends to identify areas of



☰ □ ◀

(Naan Muthalvan – AIDS, CSE & IT Department)



PRINCIPAL
MEENAKSHI SUNDARARAJAN ENGINEERING COLLEGE
363, ARCOT ROAD, KODAMBAKKAM
CHENNAI-600 024



MEENAKSHI SUNDARARAJAN ENGINEERING COLLEGE

(Managed by I.E.T Society, Approved by AICTE, New Delhi,

Affiliated to Anna University, Chennai,

Accredited by NAAC with 'A' grade and NBA for programs applied,

Recognized by UGC with 2(f) & 12(B) status)



363, Arcot Road, Kodambakkem, Chennai – 600 024, Tamil Nadu, India

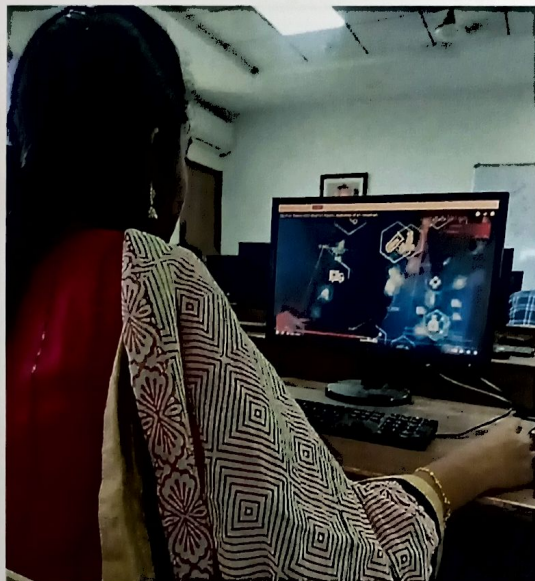
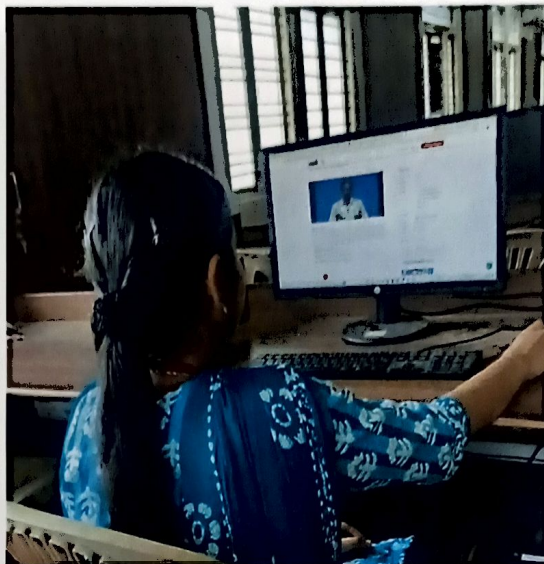

EXPLORING IOT PROJECTS THROUGH YOUTUBE(ECE Department)



MEENAKSHI SUNDARARAJAN ENGINEERING COLLEGE

(Managed by I.I.E.T. Society, Approved by AICTE, New Delhi)

Affiliated to Anna University, Chennai

Accredited by NAAC with 'A' grade and NBA for programs applied

Recognized by UGC with 2(F) & 12(B) status

363, Arcot Road, Kodambakkam, Chennai – 600 024, Tamil Nadu, India



(NPTEL COURSE – ECE Department)



Elite

NPTEL Online Certification

(Funded by the MoE, Govt. of India)



This certificate is awarded to

GISHNURAJ SK

for successfully completing the course



Cloud Computing

with a consolidated score of **76** %

Online Assignments	23.31/25	Proctored Exam	52.86/75
--------------------	----------	----------------	----------

Total number of candidates certified in this course: 23872

Jan-Apr 2024
(12 week course)

Banerji
Prof. Haimanti Banerji
Coordinator, NPTEL
IIT Kharagpur



Indian Institute of Technology Kharagpur



Roll No: NPTEL24CS175453506881

To verify the certificate



No. of credits recommended: 3 or 4

(NPTEL Certificate – ECE Student)

PRINCIPAL
MEENAKSHI SUNDARARAJAN ENGINEERING COLLEGE
363, ARCOT ROAD, KODAMBAKKAM
CHENNAI-600 024



MEENAKSHI SUNDARARAJAN ENGINEERING COLLEGE

(Managed by I.I.E.T Society, Approved by AICTE, New Delhi)

Affiliated to Anna University, Chennai.

Accredited by NAAC with 'A' grade and NBA for programs applied,

Recognized by UGC with 2(F) & 12(B) status)

363, Arcot Road, Kodambakkam, Chennai – 600 024, Tamil Nadu, India



This is to certify that

ARAVINDHA HARINI R

has successfully completed the **Digital Productivity training on Cyber Security and Data Privacy** offered by Naan Mudhalvan in partnership with Microsoft and conducted by Infispark Foundation on December 21, 2023.



(NPTEL Certificate – ECE Student)



Elite

NPTEL Online Certification

(Funded by the MoE, Govt. of India)

This certificate is awarded to

GAYATHRI R

for successfully completing the course

Programming in Java



with a consolidated score of **78 %**

Online Assignments	24.94/25	Proctored Exam	53.38/75
--------------------	----------	----------------	----------

Total number of candidates certified in this course: 14693

Jan-Apr 2024

(12 week course)

Prof. Naimanti Banerji
Prof. Naimanti Banerji
Coordinator, NPTEL
IIT Kharagpur



Indian Institute of Technology Kharagpur



Roll No: NPTEL24CS43S753402988

To verify the certificate



No. of credits recommended: 3 or 4

(NPTEL Certificate – CSE Student)

PRINCIPAL

MEENAKSHI SUNDARARAJAN ENGINEERING COLLEGE
363, ARCOT ROAD, KODAMBAKKAM
CHENNAI-600 024



MEENAKSHI SUNDARARAJAN ENGINEERING COLLEGE

(Managed by I.E.T. Society, Approved by AICTE, New Delhi,

Affiliated to Anna University, Chennai,

Accredited by NAAC with 'A' grade and NBA for programs applied,

Recognized by UGC with 2(f) & 12(B) status)

363, Arcot Road, Kodambakkam, Chennai – 600 024, Tamil Nadu, India



11. Demo based learning



Topic : Solar PV system with grid connected system

Demo based learning-Theoretical concept (EEE Department)

PRINCIPAL
MEENAKSHI SUNDARARAJAN ENGINEERING COLLEGE
363, ARCOT ROAD, KODAMBAKKAM
CHENNAI-600 024



MEENAKSHI SUNDARARAJAN ENGINEERING COLLEGE

(Managed by I.I.E.T Society, Approved by AICTE, New Delhi,

Affiliated to Anna University, Chennai,

Accredited by NAAC with 'A' grade and NBA for programs applied,

Recognized by UGC with 2(f) & 12(B) status)

363, Arcot Road, Kodambakkam, Chennai – 600 024, Tamil Nadu, India

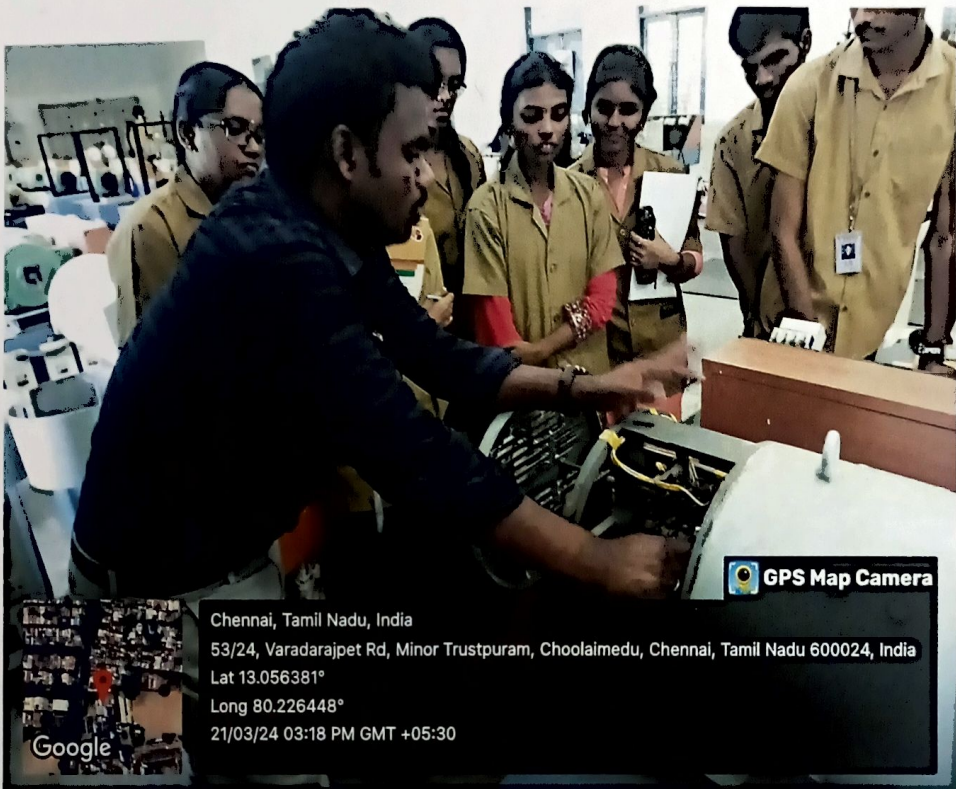

Demo based learning-Theoretical concept (EEE Department)



PRINCIPAL
MEENAKSHI SUNDARARAJAN ENGINEERING COLLEGE
363, ARCOT ROAD, KODAMBAKKAM
CHENNAI-600 024